

Ultra low drop-low noise BiCMOS voltage regulators low ESR capacitors compatible

Features

- Input voltage from 2.5 V to 6 V
- Stable with low ESR ceramic capacitors
- Ultra low dropout voltage (60 mV typ. at 150 mA load, 0.4 mV typ. at 1 mA load)
- Very low quiescent current (85 μ A typ. at no load, 170 μ A typ. at 150 mA load; max 1.5 μ A in OFF mode)
- Guaranteed output current up to 150 mA
- Wide range of output voltage: 1.22 V; 1.8 V; 2.5 V; 2.6 V; 2.7 V; 2.8 V; 2.9 V; 3 V; 3.3 V; 4.7 V
- Fast turn-on time: typ. 200 μ s [$C_O = 1 \mu$ F, $C_{BYP} = 10$ nF and $I_O = 1$ mA]
- Logic-controlled electronic shutdown
- Internal current and thermal limit
- Output low noise voltage 30 μ V_{RMS} over 10 Hz to 100 kHz
- SVR of 60 dB at 1 kHz, 50 dB at 10 kHz
- Temperature range: - 40 °C to 125 °C

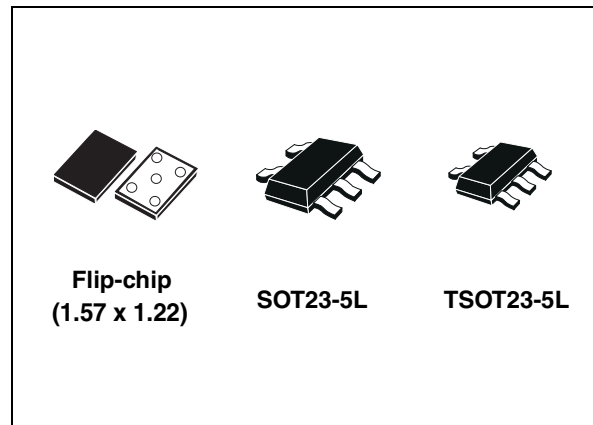

to roll off at 10 kHz. High power supply rejection is maintained down to low input voltage levels common to battery operated circuits. Shutdown logic control function is available, this means that when the device is used as local regulator, it is possible to put a part of the board in standby, decreasing the total power consumption. The LD3985xx is designed to work with low ESR ceramic capacitors. Typical applications are in mobile phone and similar battery powered wireless systems.

Description

The LD3985xx provides up to 150 mA, from 2.5 V to 6 V input voltage. The ultra low drop-voltage, low quiescent current and low noise make it suitable for low power applications and in battery powered systems. Regulator ground current increases only slightly in dropout, further prolonging the battery life. Power supply rejection is better than 60 dB at low frequencies and starts

Table 1. Device summary

Part numbers	
LD3985XX122	LD3985XX28
LD3985XX18	LD3985XX29
LD3985XX25	LD3985XX30
LD3985XX26	LD3985XX33
LD3985XX27	LD3985XX47

Contents

1	Diagram	3
2	Pin configuration	4
3	Typical application	5
4	Maximum ratings	6
5	Electrical characteristics	7
6	Typical performance characteristics	9
7	Package mechanical data	13
8	Order codes	21
9	Revision history	22

1 Diagram

Figure 1. Schematic diagram

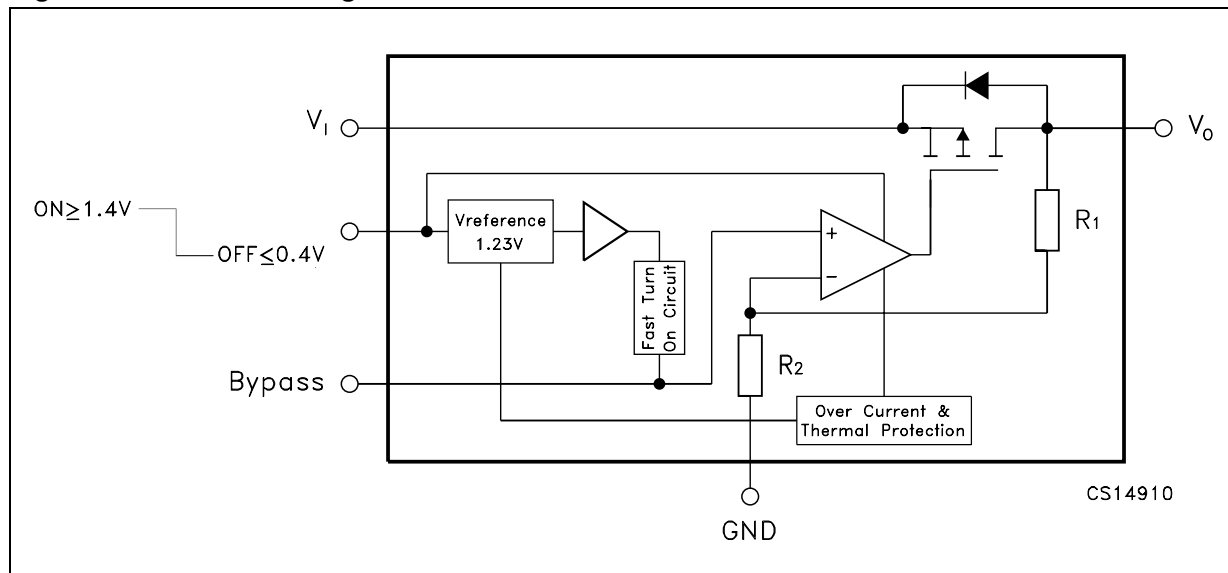

2 Pin configuration

Figure 2. Pin connections (top view for SOT and TSOT, top through view for Flip-chip)

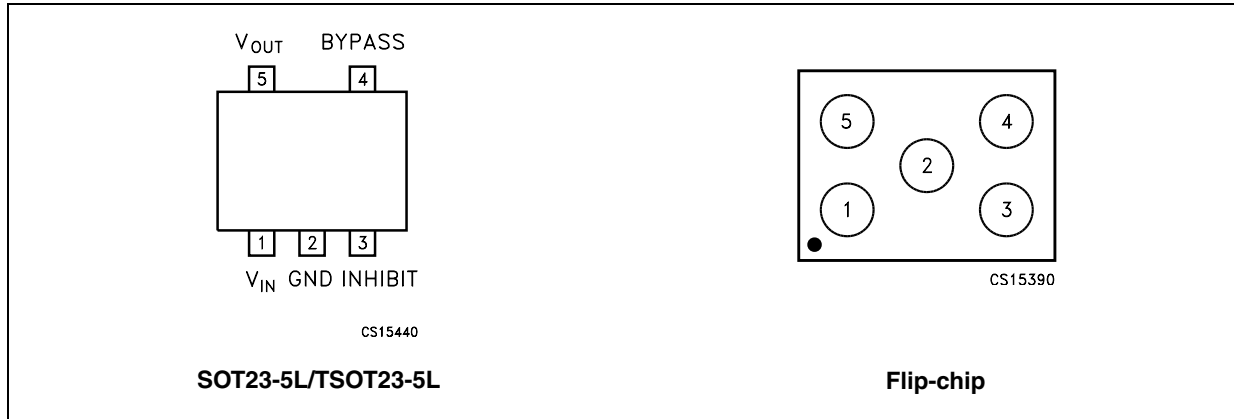
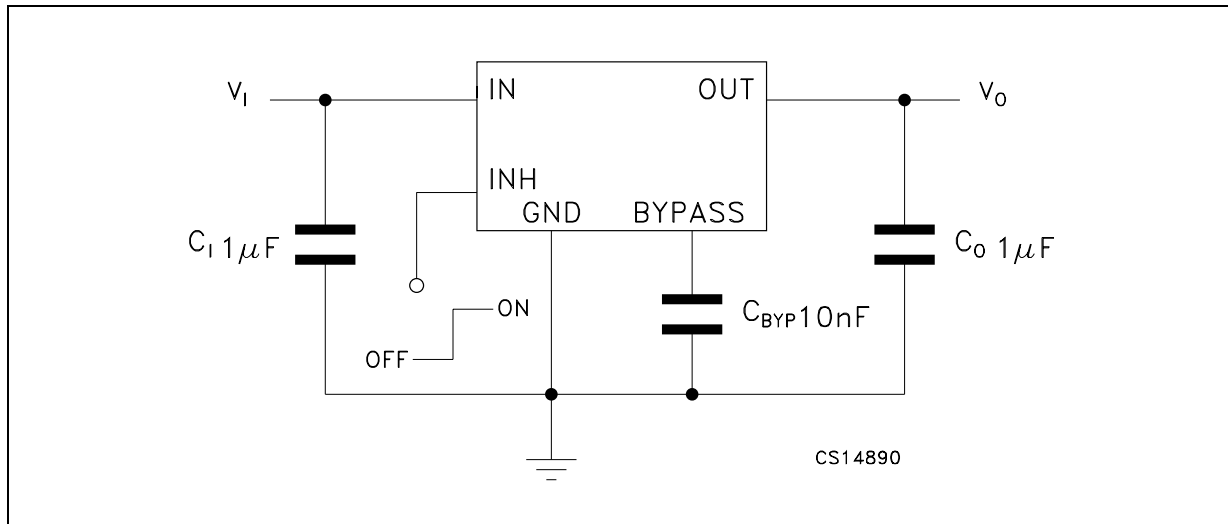

Table 2. Pin description

Pin n° for SOT23-5L/TSOT23-5L	Pin n° for Flip-chip	Symbol	Name and function
1	4	V_I	Input voltage of the LDO
2	2	GND	Common ground
3	1	V_{INH}	Inhibit input voltage: ON MODE when $V_{INH} \geq 1.2\text{ V}$, OFF MODE when $V_{INH} \leq 0.4\text{ V}$ (Do not leave floating, not internally pulled down/up)
4	5	BYPASS	Bypass pin: connect an external capacitor (usually 10 nF) to minimize noise voltage
5	3	V_O	Output voltage of the LDO

3 Typical application

Figure 3. Typical application circuit



4 Maximum ratings

Table 3. Absolute maximum ratings

Symbol	Parameter	Value	Unit
V_I	DC input voltage	-0.3 to 6 ⁽¹⁾	V
V_O	DC output voltage	-0.3 to $V_I+0.3$	V
V_{INH}	INHIBIT input voltage	-0.3 to $V_I+0.3$	V
I_O	Output current	Internally limited	
P_D	Power dissipation	Internally limited	
T_{STG}	Storage temperature range	-65 to 150	°C
T_{OP}	Operating junction temperature range	-40 to 125	°C

1. The input pin is able to withstand non repetitive spike of 6.5 V for 200 ms.

Note: Absolute maximum ratings are those values beyond which damage to the device may occur. Functional operation under these condition is not implied.

Table 4. Thermal data

Symbol	Parameter	SOT23-5L/ TSOT23	Flip-chip	Unit
R_{thJC}	Thermal resistance junction-case	81		°C/W
R_{thJA}	Thermal resistance junction-ambient	255	170	°C/W

5 Electrical characteristics

$T_J = 25\text{ }^\circ\text{C}$, $V_I = V_{O(NOM)} + 0.5\text{ V}$, $C_I = 1\text{ }\mu\text{F}$, $C_{BYP} = 10\text{ nF}$, $I_O = 1\text{ mA}$, $V_{INH} = 1.4\text{ V}$, unless otherwise specified.

Table 5. Electrical characteristics for LD3985

Symbol	Parameter	Test conditions	Min.	Typ.	Max.	Unit
V_I	Operating input voltage		2.5		6	V
V_O	Output voltage < 2.5 V	$I_O = 1\text{ mA}$	-50		50	mV
		$T_J = -40\text{ to }125\text{ }^\circ\text{C}$	-75		75	
V_O	Output voltage $\geq 2.5\text{ V}$	$I_O = 1\text{ mA}$	-2		2	% of $V_{O(NOM)}$
		$T_J = -40\text{ to }125\text{ }^\circ\text{C}$	-3		3	
ΔV_O	Line regulation ⁽¹⁾	$V_I = V_{O(NOM)} + 0.5\text{ to }6\text{ V}$ $T_J = -40\text{ to }125\text{ }^\circ\text{C}$	-0.1		0.1	%V
		$V_O = 4.7\text{ to }5\text{ V}$	-0.19		0.19	
ΔV_O	Load regulation	$I_O = 1\text{ mA to }150\text{ mA}$, $V_O < 2.5\text{ V}$ $T_J = -40\text{ to }125\text{ }^\circ\text{C}$		0.002	0.008	%/mA
ΔV_O	Load regulation	$I_O = 1\text{ mA to }150\text{ mA}$, $V_O \geq 2.5\text{ V}$ $T_J = -40\text{ to }125\text{ }^\circ\text{C}$ (for flip-chip)		0.0004	0.002	% /mA
		$I_O = 1\text{ mA to }150\text{ mA}$, $T_J = -40\text{ to }125\text{ }^\circ\text{C}$ (for SOT23-5L/TSOT23-5L), $V_O \geq 2.5\text{ V}$		0.0025	0.005	
ΔV_O	Output AC Line regulation ⁽²⁾	$V_I = V_{O(NOM)} + 1\text{ V}$, $I_O = 150\text{ mA}$, $t_R = t_F = 30\mu\text{s}$		1.5		mV _{PP}
I_Q	Quiescent current ON MODE: $V_{INH} = 1.2\text{ V}$	$I_O = 0$		85		μA
		$I_O = 0$, $T_J = -40\text{ to }125\text{ }^\circ\text{C}$			150	
		$I_O = 0\text{ to }150\text{ mA}$		170		
		$I_O = 0\text{ to }150\text{ mA}$, $T_J = -40\text{ to }125\text{ }^\circ\text{C}$			250	
	OFF MODE: $V_{INH} = 0.4\text{ V}$		0.003			
		$T_J = -40\text{ to }125\text{ }^\circ\text{C}$			1.5	
V_{DROP}	Dropout voltage ⁽³⁾	$I_O = 1\text{ mA}$		0.4		mV
		$I_O = 1\text{ mA}$, $T_J = -40\text{ to }125\text{ }^\circ\text{C}$			2	
		$I_O = 50\text{ mA}$		20		
		$I_O = 50\text{ mA}$, $T_J = -40\text{ to }125\text{ }^\circ\text{C}$			35	
		$I_O = 100\text{ mA}$		45		
		$I_O = 100\text{ mA}$, $T_J = -40\text{ to }125\text{ }^\circ\text{C}$			70	
		$I_O = 150\text{ mA}$		60		
		$I_O = 150\text{ mA}$, $T_J = -40\text{ to }125\text{ }^\circ\text{C}$			100	
I_{SC}	Short circuit current	$R_L = 0$		600		mA

Table 5. Electrical characteristics for LD3985 (continued)

Symbol	Parameter	Test conditions	Min.	Typ.	Max.	Unit
SVR	Supply voltage rejection	$V_I = V_{O(NOM)} + 0.25V \pm$ $V_{RIPPLE} = 0.1V, I_O = 50mA$ $V_{O(NOM)} < 2.5V, V_I = 2.55V$	f = 1kHz	60		dB
			f = 10kHz	50		
$I_{O(PK)}$	Peak output current	$V_O \geq V_{O(NOM)} - 5\%$	300	550		mA
V_{INH}	Inhibit input logic low	$V_I = 2.5V$ to $6V, T_J = -40$ to $125^\circ C$			0.4	V
	Inhibit input logic high		1.2			
I_{INH}	Inhibit input current	$V_{INH} = 0.4V, V_I = 6V$		± 1		nA
eN	Output noise voltage	$B_W = 10$ Hz to 100 kHz, $C_O = 1\mu F$		30		μV_{RMS}
t_{ON}	Turn On time ⁽⁴⁾	$C_{BYP} = 10$ nF		100	250	μs
T_{SHDN}	Thermal shutdown	⁽⁵⁾		160		$^\circ C$
C_O	Output capacitor	Capacitance ⁽⁶⁾	1		22	μF
		ESR	5		5000	m Ω

- For $V_{O(NOM)} < 2$ V, $V_I = 2.5$ V
- For $V_{O(NOM)} = 1.25$ V, $V_I = 2.5$ V
- Dropout voltage is the input-to-output voltage difference at which the output voltage is 100 mV below its nominal value. This specification does not apply for input voltages below 2.5 V
- Turn-on time is time measured between the enable input just exceeding V_{INH} High Value and the output voltage just reaching 95 % of its nominal value
- Typical thermal protection hysteresis is 20 $^\circ C$
- The minimum capacitor value is 1 μF , anyway the LD3985 is still stable if the compensation capacitor has a 30 % tolerance in all temperature range

6 Typical performance characteristics

$T_J = 25\text{ }^\circ\text{C}$, $V_I = V_{O(NOM)} + 0.5\text{ V}$, $C_I = C_O = 1\text{ }\mu\text{F}$, $C_{BYP} = 10\text{ nF}$, $I_O = 1\text{ mA}$, $V_{INH} = 1.4\text{ V}$, unless otherwise specified.

Figure 4. Output voltage vs. temperature

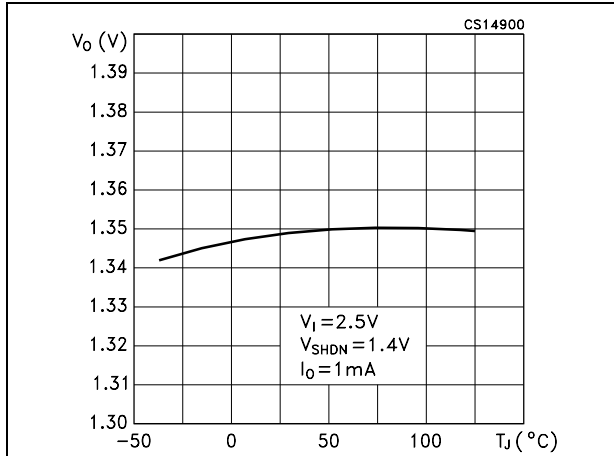

Figure 5. Output voltage vs. temperature

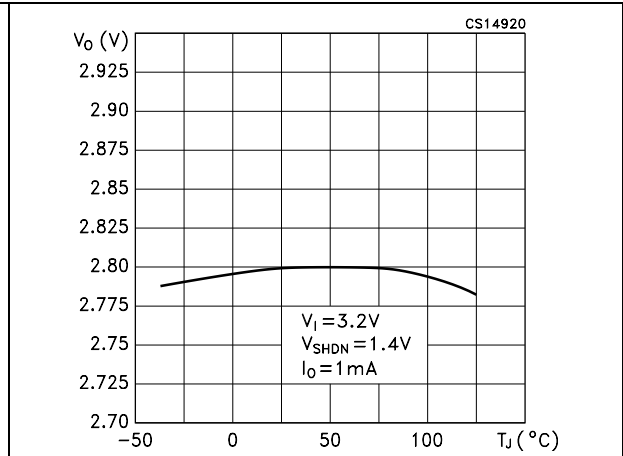

Figure 6. Output voltage vs. temperature

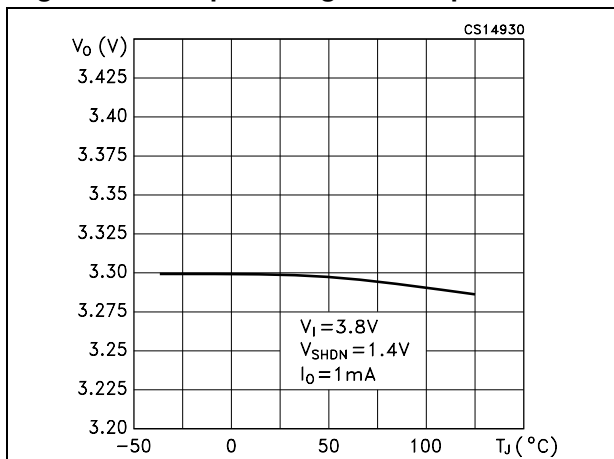

Figure 7. Shutdown voltage vs. temperature

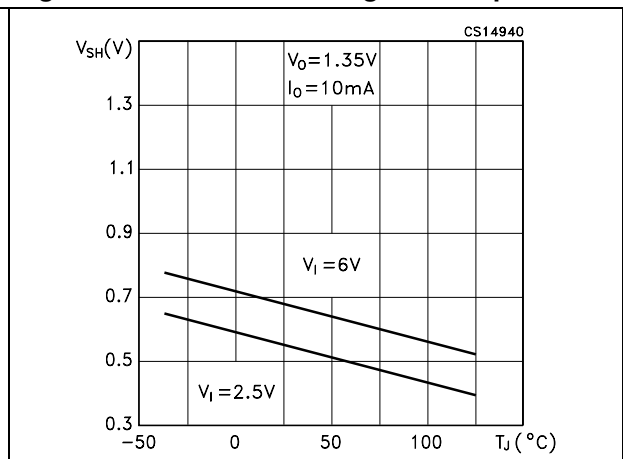

Figure 8. Shutdown voltage vs. temperature

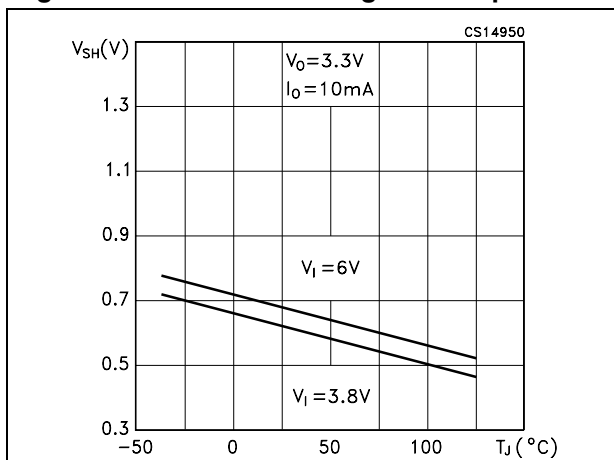

Figure 9. Line regulation vs. temperature

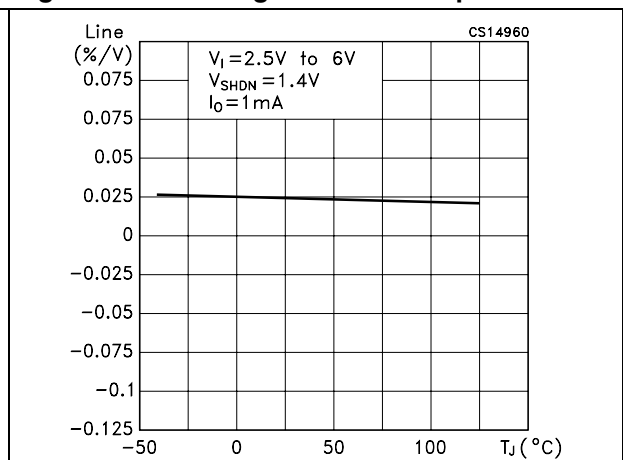

Figure 10. Line regulation vs. temperature

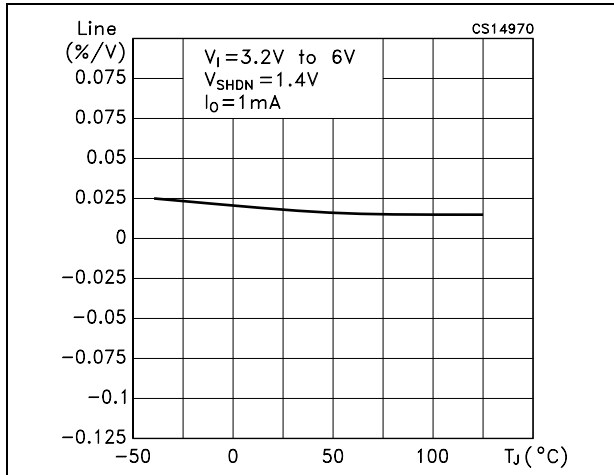

Figure 11. Line regulation vs. temperature

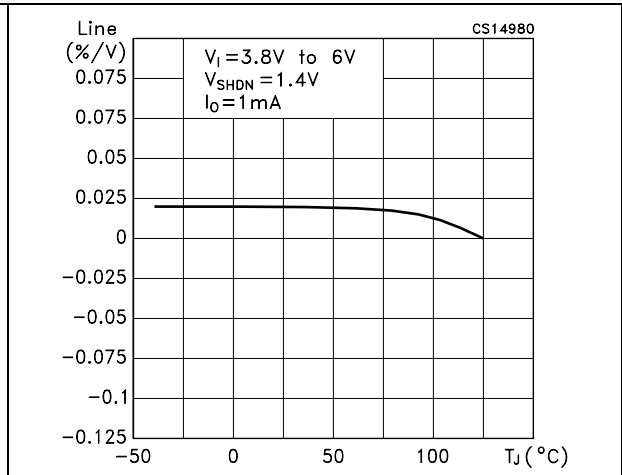

Figure 12. Load regulation vs. temperature

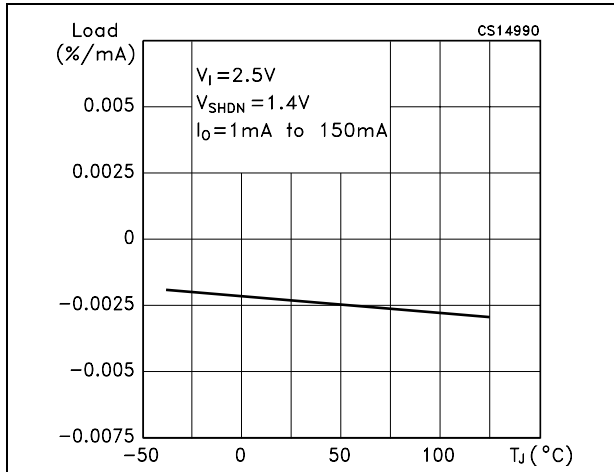

Figure 13. Load regulation vs. temperature

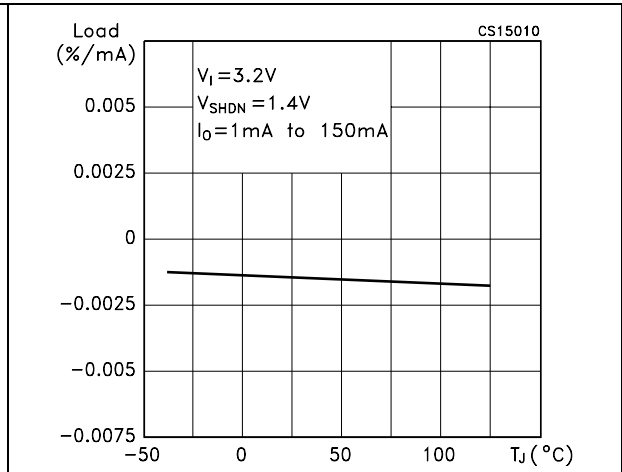

Figure 14. Load regulation vs. temperature

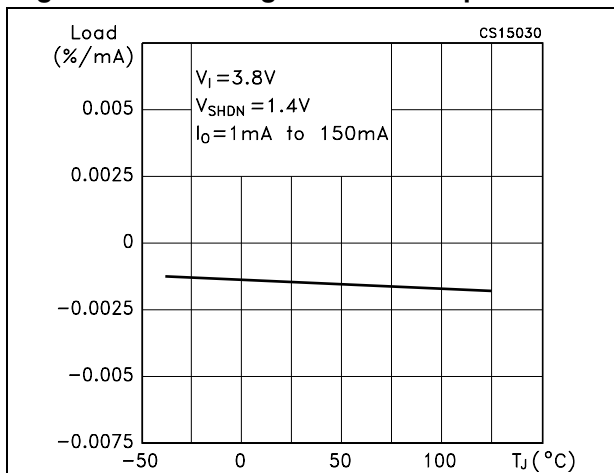

Figure 15. Quiescent current vs. temperature

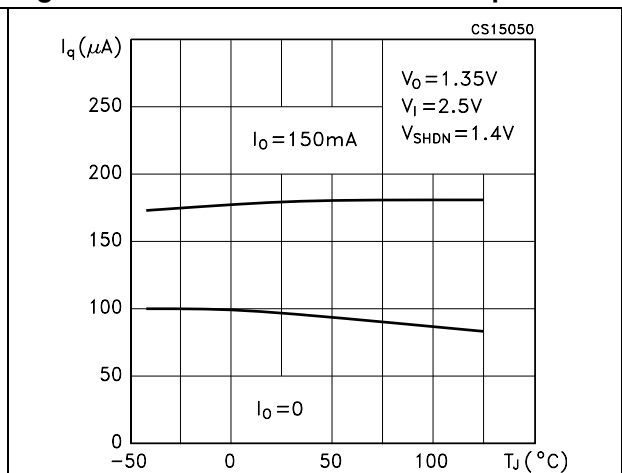

Figure 16. Quiescent current vs. temperature

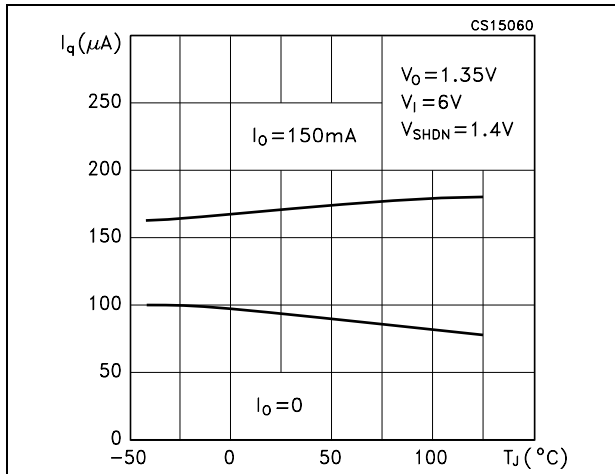

Figure 17. Quiescent current vs. temperature

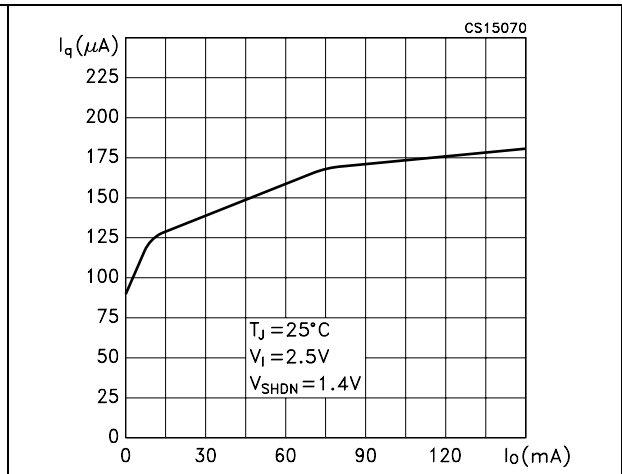

Figure 18. Supply voltage rejection vs. frequency

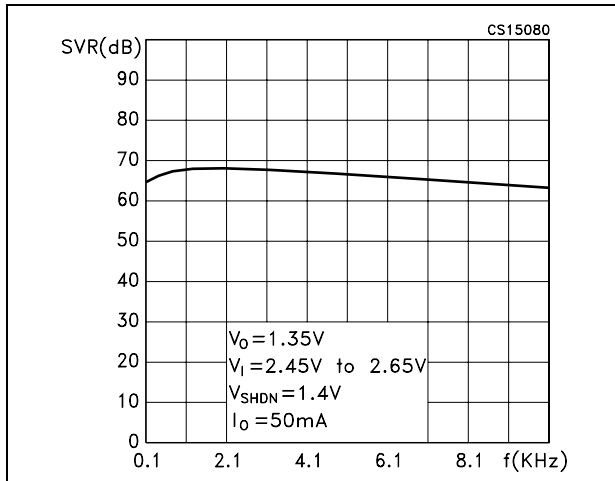

Figure 19. Load transient response

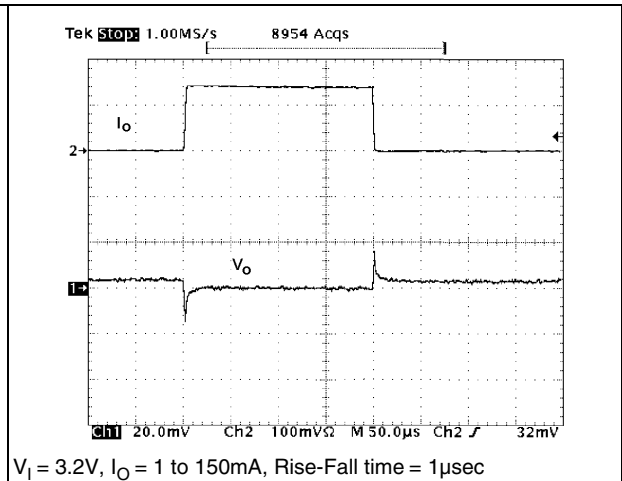

Figure 20. Line transient response

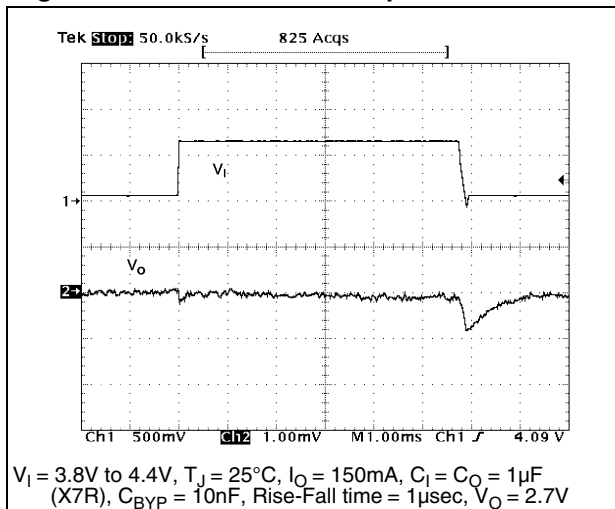

Figure 21. Start-Up

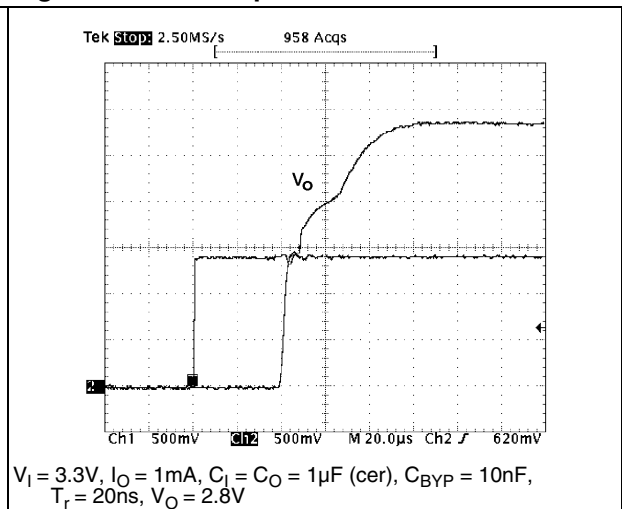
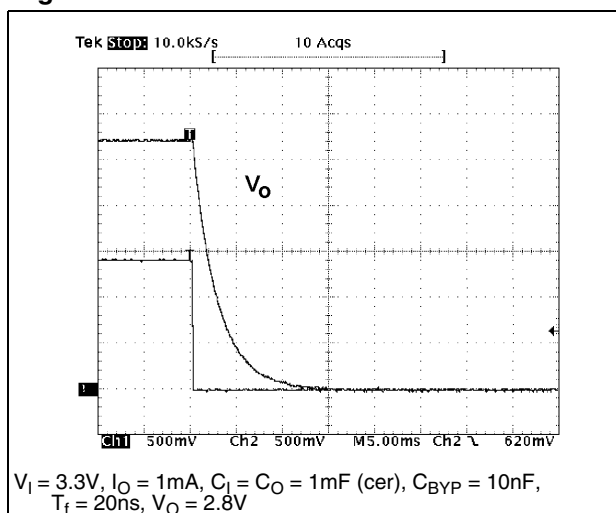

Figure 22. Turn-Off



7 Package mechanical data

In order to meet environmental requirements, ST offers these devices in different grades of ECOPACK[®] packages, depending on their level of environmental compliance. ECOPACK[®] specifications, grade definitions and product status are available at: www.st.com. ECOPACK[®] is an ST trademark.

SOT23-5L mechanical data

Dim.	mm.			mils.		
	Min.	Typ.	Max.	Min.	Typ.	Max.
A	0.90		1.45	35.4		57.1
A1	0.00		0.10	0.0		3.9
A2	0.90		1.30	35.4		51.2
b	0.35		0.50	13.7		19.7
C	0.09		0.20	3.5		7.8
D	2.80		3.00	110.2		118.1
E	1.50		1.75	59.0		68.8
e		0.95			37.4	
H	2.60		3.00	102.3		118.1
L	0.10		0.60	3.9		23.6

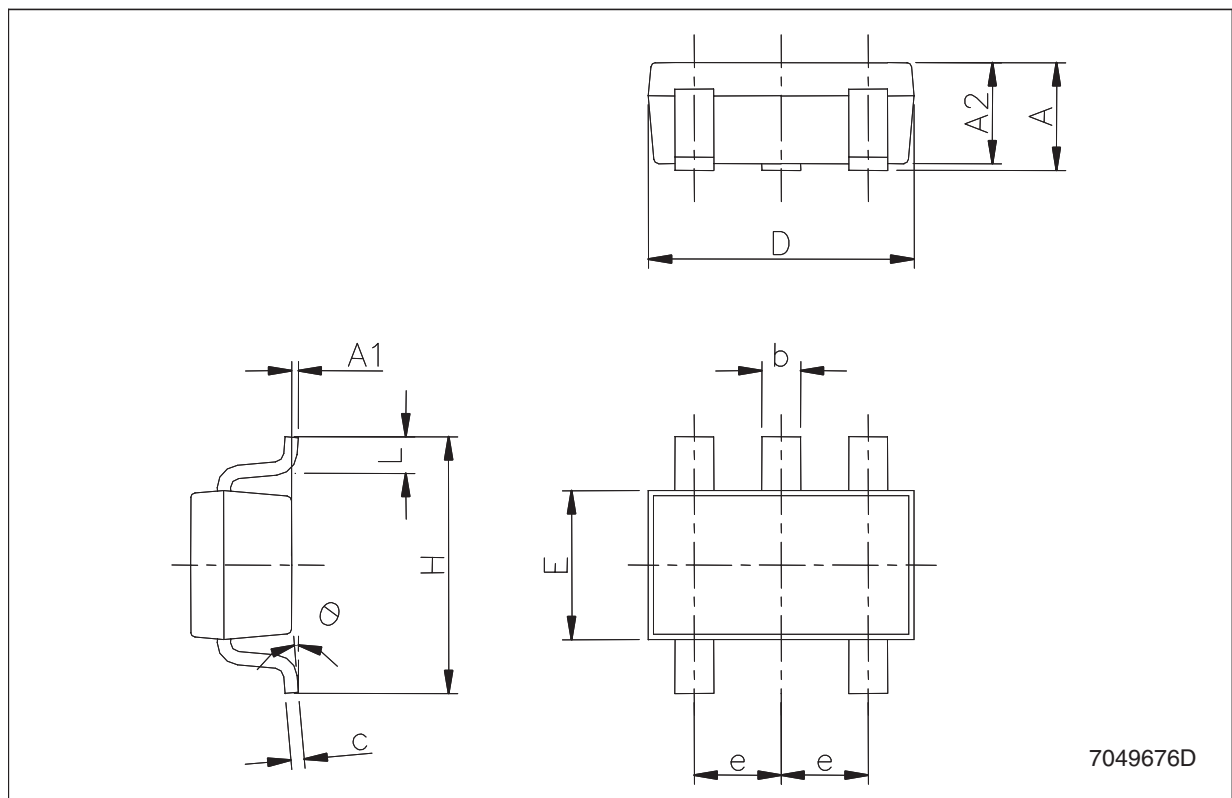

TSOT23-5L mechanical data

Dim.	mm.			mils.		
	Min.	Typ.	Max.	Min.	Typ.	Max.
A			1.1			43.3
A1	0		0.1			3.9
A2	0.7		1.0	27.6		39.4
b	0.3		0.5	11.8		19.7
C	0.08		0.2	3.1		7.9
D		2.9			114.2	
E		2.8			110.2	
E1		1.6			63.0	
e		0.95			37.4	
e1		1.9			74.8	
L	0.3		0.6	11.8		23.6

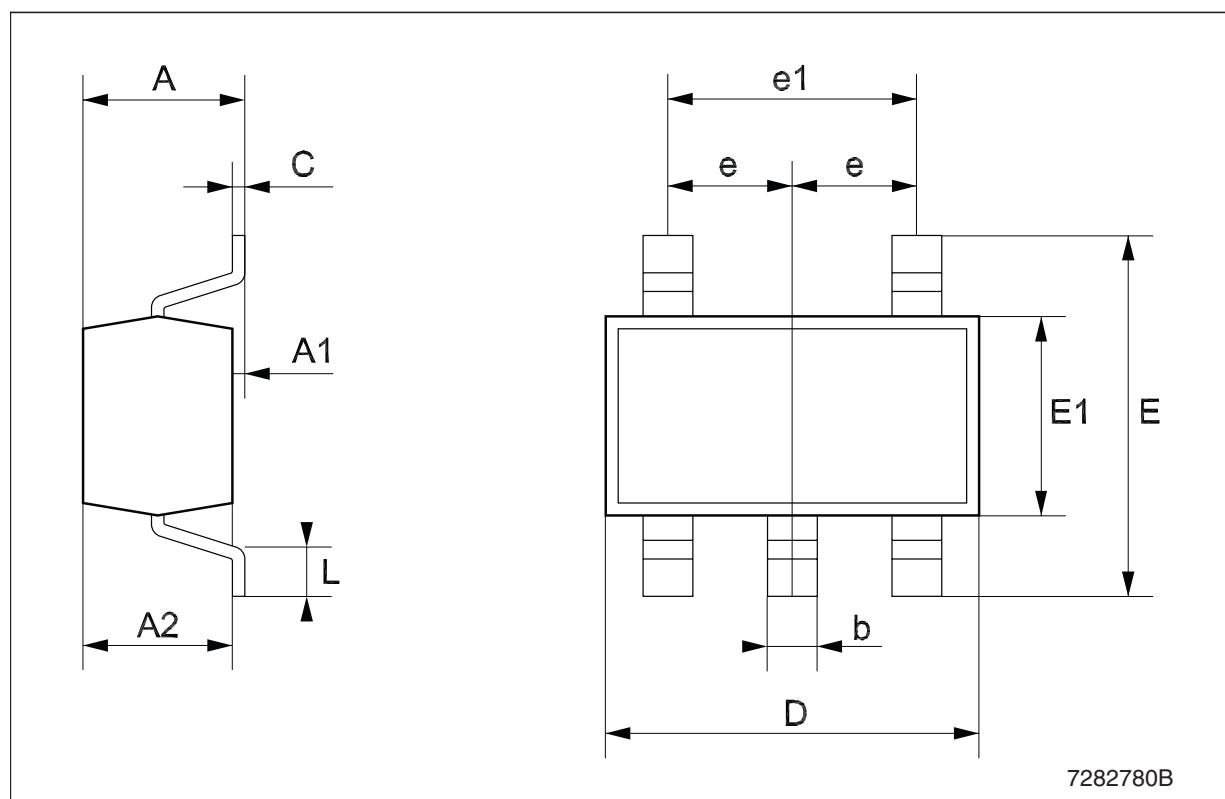
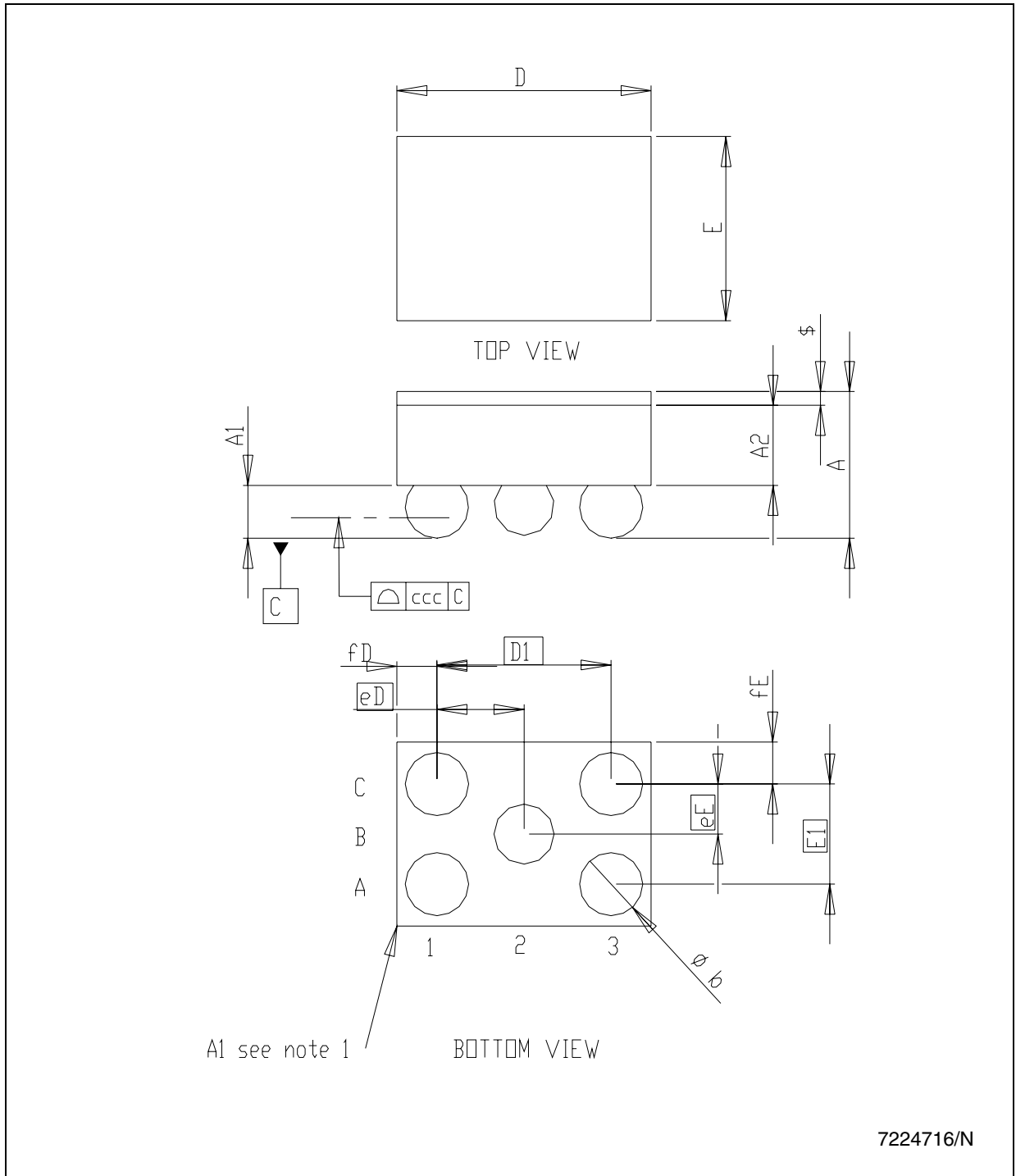

Table 6. Flip-chip 5 mechanical data

mm.			
Dim.	Min.	Typ.	Max.
A	0.54	0.65	0.66
A1	0.21	0.25	0.29
A2	0.33	0.35	0.37
b	0.265	0.315	0.365
D	1.54	1.59	1.64
D1	0.83	0.87	0.91
E	1.19	1.24	1.29
E1	0.46	0.5	0.54
eD	0.395	0.435	0.475
eE	0.21	0.25	0.29
fD		0.360	
fE		0.370	
ccc		0.080	
\$		0.05	

Figure 23. Drawing dimension Flip-chip 5



Tape & reel SOT23-xL mechanical data

Dim.	mm.			inch.		
	Min.	Typ.	Max.	Min.	Typ.	Max.
A			180			7.086
C	12.8	13.0	13.2	0.504	0.512	0.519
D	20.2			0.795		
N	60			2.362		
T			14.4			0.567
Ao	3.13	3.23	3.33	0.123	0.127	0.131
Bo	3.07	3.17	3.27	0.120	0.124	0.128
Ko	1.27	1.37	1.47	0.050	0.054	0.058
Po	3.9	4.0	4.1	0.153	0.157	0.161
P	3.9	4.0	4.1	0.153	0.157	0.161

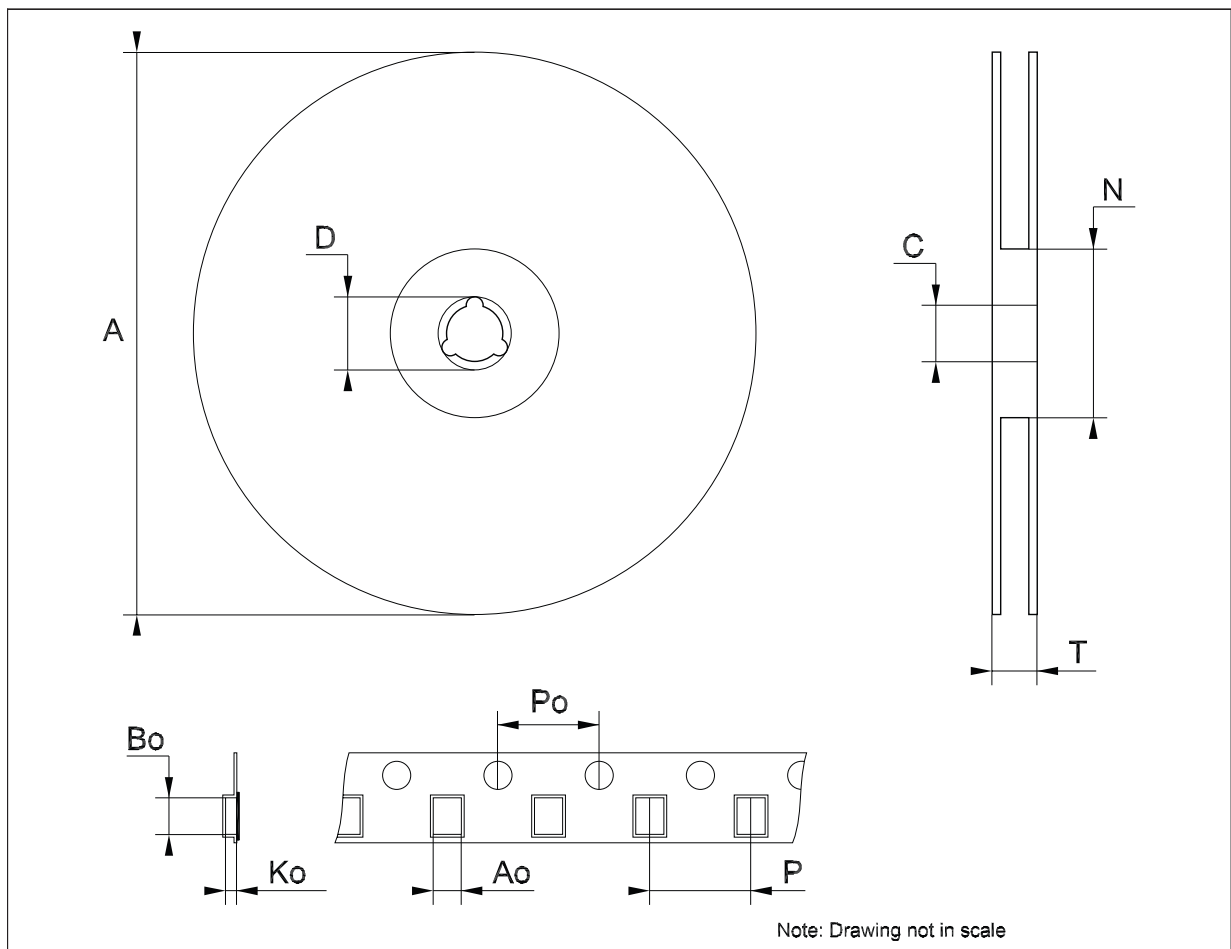

Tape & reel Flip-chip 5 mechanical data

Dim.	mm.			inch.		
	Min.	Typ.	Max.	Min.	Typ.	Max.
A			178			6.926
C	12.8		13.2	0.504		0.519
D	20.2			0.795		
N	49	50	51	1.929	1.969	2.008
T			12.4			0.488
Ao	1.60	1.65	1.70	0.063	0.065	0.067
Bo	1.27	1.32	1.37	0.050	0.052	0.054
Ko	0.76	0.81	0.86	0.030	0.032	0.034
Po	3.9	4	4.1	0.153	0.157	0.161
P	3.9	4	4.1	0.153	0.157	0.161

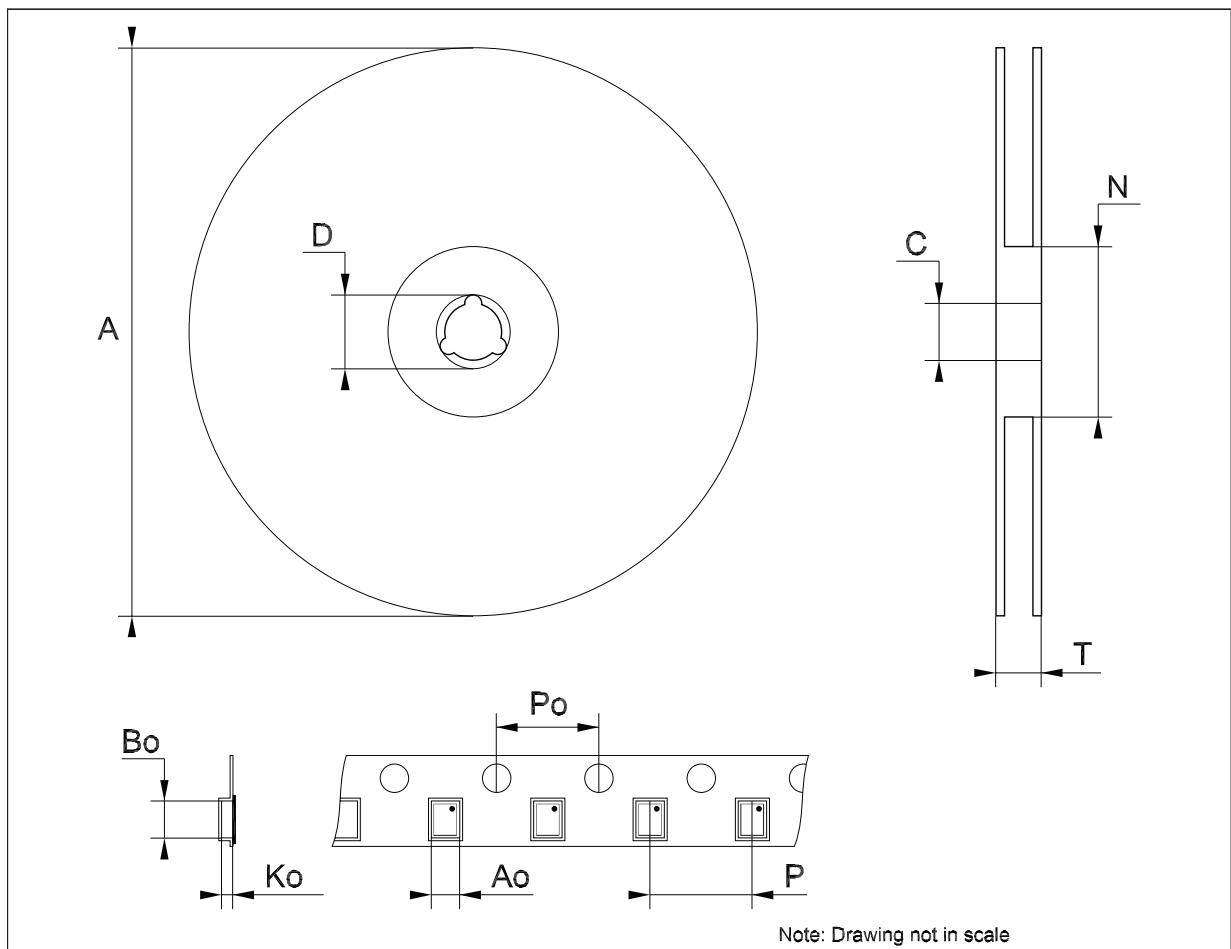

Tape & reel TSOT23-5L mechanical data

Dim.	mm.			inch.		
	Min.	Typ.	Max.	Min.	Typ.	Max.
A			180			7.086
C	12.8	13.0	13.2	0.504	0.512	0.519
D	20.2			0.795		
N	60			2.362		
T			14.4			0.567
Ao	3.13	3.23	3.33	0.123	0.127	0.131
Bo	3.07	3.17	3.27	0.120	0.124	0.128
Ko	1.27	1.37	1.47	0.050	0.054	0.058
Po	3.9	4.0	4.1	0.153	0.157	0.161
P	3.9	4.0	4.1	0.153	0.157	0.161

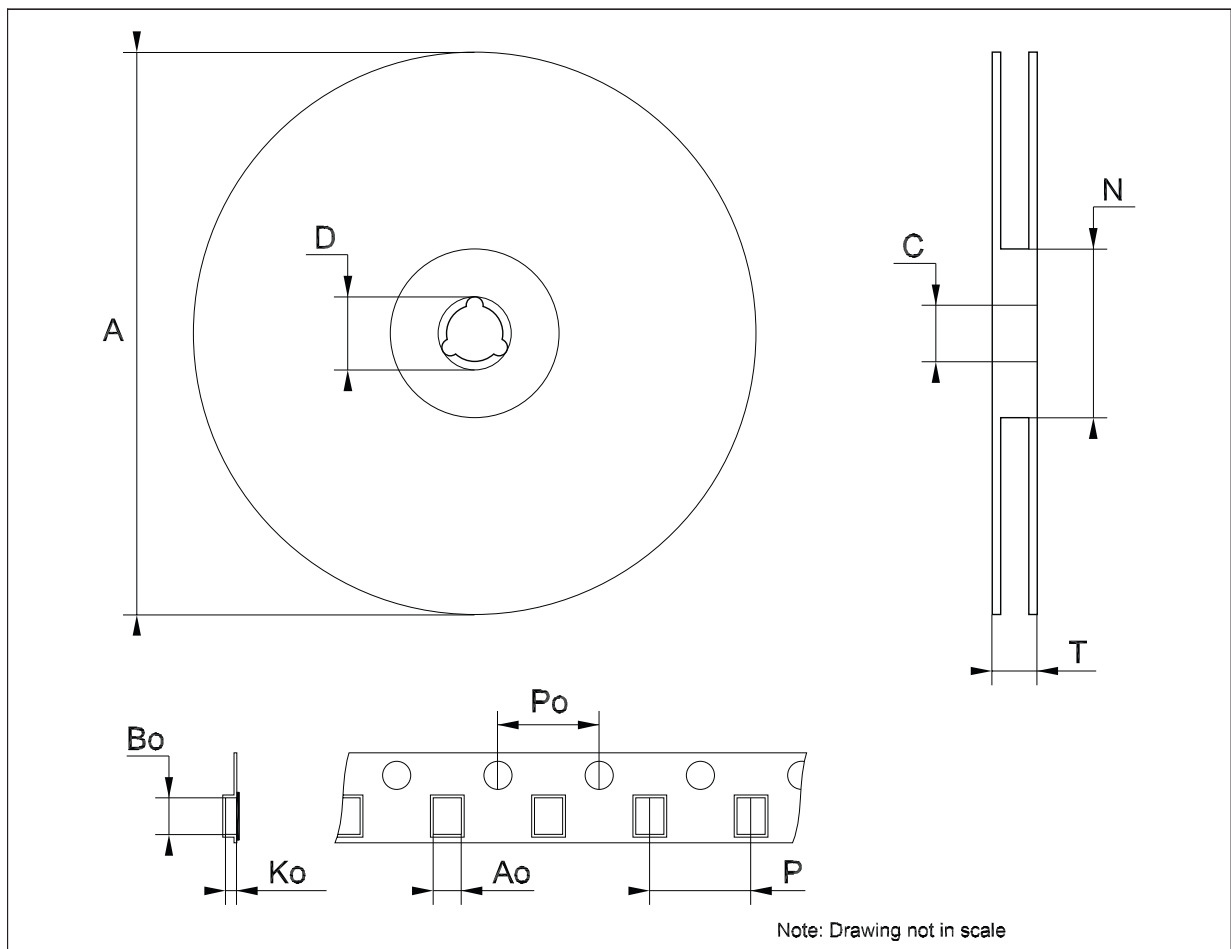

8 Order codes

Table 7. Order codes

Packages			
SOT23-5L	TSOT23-5L	Flip-chip	Output voltage
LD3985M122R	LD3985G122R ⁽¹⁾		1.22 V
LD3985M18R	LD3985G18R	LD3985J18R	1.8 V
LD3985M25R	LD3985G25R	LD3985J25R	2.5 V
LD3985M26R ⁽¹⁾	LD3985G26R ⁽¹⁾	LD3985J26R	2.6 V
LD3985M27R	LD3985G27R		2.7 V
LD3985M28R	LD3985G28R	LD3985J28R	2.8 V
LD3985M29R		LD3985J29R	2.9 V
LD3985M30R	LD3985G30R	LD3985J30R	3.0 V
LD3985M33R	LD3985G33R	LD3985J33R	3.3 V
LD3985M47R	LD3985G47R		4.7 V

1. Available on request.

9 Revision history

Table 8. Document revision history

Date	Revision	Changes
07-May-2004	6	Part number status changed on table 3.
05-Oct-2004	7	t_{ON} values are changed on table 5.
27-Oct-2004	8	Order codes changed - table 3.
17-Mar-2005	9	Improved drawing quality for figures 19 - 20 - 21 - 22.
10-Apr-2007	10	Order codes updated.
08-Jun-2007	11	Order code change.
20-Dec-2007	12	Modified: Table 1 , Table 7 , mechanical data for Flip-chip.
02-Dec-2008	13	Modified: Table 6 on page 16 and Figure 23 on page 17 .
03-Jan-2011	14	Modified: Features on page 1 and Table 7 on page 21 .

Please Read Carefully:

Information in this document is provided solely in connection with ST products. STMicroelectronics NV and its subsidiaries ("ST") reserve the right to make changes, corrections, modifications or improvements, to this document, and the products and services described herein at any time, without notice.

All ST products are sold pursuant to ST's terms and conditions of sale.

Purchasers are solely responsible for the choice, selection and use of the ST products and services described herein, and ST assumes no liability whatsoever relating to the choice, selection or use of the ST products and services described herein.

No license, express or implied, by estoppel or otherwise, to any intellectual property rights is granted under this document. If any part of this document refers to any third party products or services it shall not be deemed a license grant by ST for the use of such third party products or services, or any intellectual property contained therein or considered as a warranty covering the use in any manner whatsoever of such third party products or services or any intellectual property contained therein.

UNLESS OTHERWISE SET FORTH IN ST'S TERMS AND CONDITIONS OF SALE ST DISCLAIMS ANY EXPRESS OR IMPLIED WARRANTY WITH RESPECT TO THE USE AND/OR SALE OF ST PRODUCTS INCLUDING WITHOUT LIMITATION IMPLIED WARRANTIES OF MERCHANTABILITY, FITNESS FOR A PARTICULAR PURPOSE (AND THEIR EQUIVALENTS UNDER THE LAWS OF ANY JURISDICTION), OR INFRINGEMENT OF ANY PATENT, COPYRIGHT OR OTHER INTELLECTUAL PROPERTY RIGHT.

UNLESS EXPRESSLY APPROVED IN WRITING BY AN AUTHORIZED ST REPRESENTATIVE, ST PRODUCTS ARE NOT RECOMMENDED, AUTHORIZED OR WARRANTED FOR USE IN MILITARY, AIR CRAFT, SPACE, LIFE SAVING, OR LIFE SUSTAINING APPLICATIONS, NOR IN PRODUCTS OR SYSTEMS WHERE FAILURE OR MALFUNCTION MAY RESULT IN PERSONAL INJURY, DEATH, OR SEVERE PROPERTY OR ENVIRONMENTAL DAMAGE. ST PRODUCTS WHICH ARE NOT SPECIFIED AS "AUTOMOTIVE GRADE" MAY ONLY BE USED IN AUTOMOTIVE APPLICATIONS AT USER'S OWN RISK.

Resale of ST products with provisions different from the statements and/or technical features set forth in this document shall immediately void any warranty granted by ST for the ST product or service described herein and shall not create or extend in any manner whatsoever, any liability of ST.

ST and the ST logo are trademarks or registered trademarks of ST in various countries.

Information in this document supersedes and replaces all information previously supplied.

The ST logo is a registered trademark of STMicroelectronics. All other names are the property of their respective owners.

© 2011 STMicroelectronics - All rights reserved

STMicroelectronics group of companies

Australia - Belgium - Brazil - Canada - China - Czech Republic - Finland - France - Germany - Hong Kong - India - Israel - Italy - Japan - Malaysia - Malta - Morocco - Philippines - Singapore - Spain - Sweden - Switzerland - United Kingdom - United States of America

www.st.com